



E51 Series

Digital Cordless Phone
5.8 GHz Expandable

Model Family: MD7161

Users Guide

For a copy of a large-print version of this guide, or for product-related questions, please visit us online:

www.motorola.com/cordless

Or contact us at:

1-800-353-2729 U.S.A.

1-800-461-4575 Canada

1-888-390-6456 TTY (Text Telephone)

Copyright © 2006 Motorola, Inc. All rights reserved. No part of this publication may be reproduced in any form or by any means or used to make any derivative work (such as translation, transformation or adaptation) without written permission from Motorola, Inc.

Motorola reserves the right to revise this publication and to make changes in content from time to time without obligation on the part of Motorola to provide notification of such revision or change. Motorola provides this guide without warranty of any kind, either implied or expressed, including but not limited to, the implied warranties of merchantability and fitness for a particular purpose. Motorola may make improvements or changes in the product(s) described in this manual at any time.

MOTOROLA and the Stylized M Logo are registered in the US Patent & Trademark Office. PhoneWrap is a registered trademark of Motorola, Inc. All other product or service names are the property of their respective owners.

Table of Contents

FCC Information	vii
FCC Compliance Class B Digital Device.....	vii
FCC Declaration of Conformity.....	viii
Canadian Compliance.....	viii
Federal Communications Commission (FCC) Part 68 Statement.....	viii
Industry Canada CS-03 Declaration of Conformity.....	x
Important Safety Instructions	xi
Welcome	1
Handset Overview.....	2
Base Unit Overview	3
Getting Started.....	4

Battery Safety Instructions..... 4

Installing the Battery..... 5

Charging the Handset Battery 6

Installing the Base Unit..... 7

 Selecting a Location for Your Base Unit..... 8

 Wall Mounting (Optional) 9

Basic Operations 11

 Handset Display Indicators 11

 Base Unit LEDs..... 12

 Making a Call..... 13

 Answering Calls 14

 Ending a Call 14

 Speakerphone Operation 14

Adjust Handset Volume	15
Temporary Ringer Adjustments	16
Redial Function	16
Deleting a Redial Listing	17
Mute Function	17
Locate a Misplaced Handset	18
<i>Phonebook Operations</i>	19
Storing a New Entry	20
Reviewing/Dialing from the Phonebook.....	23
Editing a Phonebook Entry	24
Delete a Single Phonebook Entry.....	24
Caller ID/Call Waiting ID	25
Reviewing Caller ID Records.....	26

Storing a Caller ID Entry in the Phonebook.....	27
Dialing from the Caller ID Log	28
Deleting a Caller ID Record	28
Deleting All Caller ID Records.....	28
Ringer Volume	29
Ringer Tone	29
Key Tone.....	30
Display Language	31
Dialing Method.....	32
Message Waiting Indicator	32
Using the Answering System.....	33
Turning the Answering System On or Off.....	34
Answering System Feature Overview	35

Menu Features Summary	36
Outgoing Messages and Announcements Overview.....	37
Recording Your Greeting	38
Review Your Announcement.....	39
Delete Your Announcement	39
Setting the Clock.....	40
About Mailboxes.....	41
Listen to Messages	41
Adjust Playback Volume	43
Delete a Specific Message	43
Delete All Messages in a Mailbox	43
Recording a Memo	44
Call Screening	44
Message Window Display.....	45

Remote Access.....	46
Remote Voice Menu Access.....	46
REMOTE ACCESS COMMANDS.....	47
Special Features.....	49
Intercom Calls	49
Call Transfer	50
Conference Call	51
In Case of Difficulty.....	52
Warranty	55
Technical Specifications.....	59

FCC Information

FCC Compliance Class B Digital Device

This equipment has been tested and found to comply with the limits for a Class B digital device, pursuant to Part 15 of the FCC Rules. These limits are designed to provide reasonable protection against harmful interference in a residential installation. This equipment generates, uses, and can radiate radio frequency energy and, if not installed and used in accordance with the instructions, may cause harmful interference to radio communications. However, there is no guarantee that interference will not occur in a particular installation. If this equipment does cause harmful interference to radio or television reception, which can be determined by turning the equipment off and on, the user is encouraged to try to correct the interference by one of the following measures:

- Reorient or relocate the receiving antenna.
- Increase the separation between the equipment and receiver.
- Connect the equipment into an outlet on a circuit different from that to which the receiver is connected.
- Consult the dealer or an experienced radio/TV technician for help.

Caution: Changes or modifications not expressly approved by Motorola for compliance could void the user's authority to operate the equipment.

This device complies with Part 15 of the FCC Rules. Operation is subject to the following two conditions: (1) This device may not cause harmful interference, and (2) this device must accept any interference received, including interference that may cause undesired operation.

FCC Declaration of Conformity

Motorola, Inc., Connected Home Solutions, 101 Tournament Drive, Horsham, PA 19044, 1-215-323-1000, declares that this cordless phone complies with 47 CFR Parts 2 and 15 of the FCC Rules as Class B digital devices.

Canadian Compliance

This Class B digital apparatus complies with Canadian ICES-003. Cet appareil numérique de la classe B est conforme à la norme NMB-003 du Canada.

Federal Communications Commission (FCC) Part 68 Statement

This Motorola cordless phone complies with Part 68 of the FCC rules and the requirements adopted by the Administrative Council for Terminal Attachments (ACTA). On the bottom of this equipment is a label that contains, among other information, a product identifier in format US: AAAEQ##TXXXX. If requested, this information must be provided to the telephone company.

The Ringer Equivalence Number (REN) is used to determine the number of devices that may be connected to the telephone line. Excessive RENs on the telephone line may result in the devices not ringing in response to an incoming call. In most, but not all areas, the sum of the RENs should not exceed five (5.0). To be certain of the number of devices that may be connected to the line, as determined by the total RENs, contact the telephone company.

For products approved after July 23, 2001, the REN for this product is part of the product identifier that has the format US: AAAEO##TXXXX. The digits represented by ## are the REN without a decimal point (e.g., 03 is a REN of 0.3). For earlier products, the REN is separately shown on the label.

This equipment uses the following USOC jack: RJ11C. A plug and jack used to connect this equipment to the premises wiring and telephone network must comply with the applicable FCC Part 68 rules and requirements adopted by the ACTA. A compliant telephone cord and modular plug is provided with this product. It is designed to be connected to a compatible modular jack that is also compliant. See installation instructions for details.

Connection to Party Line Service is subject to state tariffs. Contact the state public utility commission, public service commission, or corporation commission for information. If this equipment causes harm to the telephone network, the telephone company will notify you in advance that the temporary discontinuance of services may be required. If advance notice is not practical, the telephone company will notify the customer as soon as possible. Also, you will be advised of your right to file a complaint with the FCC if you believe it is necessary.

The telephone company may make changes in its facilities, equipment, operations, or procedures that could affect the operation of the equipment. If this happens, the telephone company will provide advance notice in order for you to make necessary modifications to maintain uninterrupted service.

If trouble is experienced with this equipment, for repair or warranty information, please contact Motorola, Inc. at 1-877-466-8646. If the equipment is causing harm to the telephone network, the telephone company may request that you disconnect the equipment from the network until the problem is solved.

This equipment is hearing aid compatible.

If your home has specially wired alarm equipment connected to the telephone line, ensure the installation of the cordless phone does not disable your alarm equipment. If you have questions about what will disable alarm equipment, consult your telephone company or a qualified installer.

CAUTION: To maintain compliance with the FCC's RF exposure guidelines place the base unit at least 20 cm from nearby persons.

For body worn operation, this phone has been tested and meets the FCC RF exposure guidelines when used with the belt clip supplied or designated for this product. Use of other accessories may not ensure compliance with FCC RF exposure guidelines.

Industry Canada CS-03 Declaration of Conformity

This product meets the applicable Industry Canada technical specifications. The Ringer Equivalence Number (REN) is an indication of the maximum number of devices allowed to be connected to a telephone interface. The termination on an interface may consist of any combination of devices subject only to the requirement that the sum of the RENs of all the devices does not exceed five.

If this equipment does cause harmful interference to radio or television reception, which can be determined by turning the equipment on and off, the user is encouraged to try to correct the interference with one or more of the following measures: Reorient or relocate the receiving antenna (that is, the antenna for the radio or television that is "receiving" the interference). Reorient or relocate and increase the separation.

Important Safety Instructions

When using your telephone equipment, basic safety precautions should always be followed to reduce the risk of fire, electric shock, and injury, including the following:

1. Read and understand all instructions.
2. Follow all warnings and instructions marked on the product.
3. Unplug this product from the wall outlet before cleaning. Do not use liquid or aerosol cleaners. Use a damp cloth for cleaning.
4. Do not use this product near water (for example, near a bathtub, kitchen sink, or swimming pool).
5. Do not place this product on an unstable surface, such as a table, shelf or stand. The product may fall, causing serious damage.
6. Slots and openings in the back or bottom of the base unit and handset are provided for ventilation. To protect them from overheating, these openings must not be blocked by placing the product on a soft surface such as a bed, sofa, or rug. This product should never be placed near or over a radiator or heat register. This product should not be placed in any area where proper ventilation is not provided.

7. This product should be operated only from the type of power source indicated on the marking label. If you are not sure of the type of power supply in your home, consult your dealer or local power company.
8. Do not allow anything to rest on the power cord. Do not install this product where the cord may have anyone walking on it.
9. Never push objects of any kind into this product through slots in the base or handset as they may touch dangerous voltage points or short out parts that could result in a risk of fire or electric shock.
10. Never spill liquid of any kind on the product.
11. To reduce the risk of electric shock, do not disassemble this product, but take it to an authorized service facility. Opening or removing parts of the base or handset other than specified access doors may expose you to dangerous voltages or other risks. Incorrect reassembling can cause electric shock when the product is subsequently used.
12. Do not overload wall outlets and extension cords as this can result in the risk of fire or electric shock.

13. Unplug this product from the wall outlet and refer servicing to an authorized service facility under the following conditions:
 - When the power supply cord or plug is damaged or frayed.
 - If liquid has been spilled onto the product.
 - If the product has been exposed to rain or water.
 - If the product does not operate normally by following the operating instructions. Adjust only those controls that are covered by the operating instructions, as improper adjustment of other controls may result in damage and often requires extensive work by an authorized technician to restore the product to normal operation.
 - If the product has been dropped and the base and/or handset has been damaged.
 - If the product exhibits a distinct change in performance.
14. Avoid using a telephone (other than cordless) during an electrical storm. There is a remote risk of electric shock from lightning.
15. Do not use the telephone to report a gas leak in the vicinity of the leak.
16. Only put the handset of your telephone next to your ear when it is in normal talk mode.

Welcome

Congratulations on your purchase of a Motorola MD7161 series telephone. Check the contents listing on the product packaging to ensure that your purchase includes each of the items listed.

Product registration is an important step toward enjoying your new Motorola product. Registering helps us facilitate warranty service, and permits us to contact you should your Motorola product require an update or other service. Registration is not required for warranty coverage.

To register your product online, visit:

<http://broadbandregistration.motorola.com>

Product registration is not available in Canada.

Please retain your original dated sales receipt for your records. For warranty service of your Motorola product, you will need to provide a copy of your dated sales receipt to confirm warranty status.

Handset Overview

1. Earpiece
2. LCD display
3. Select/Menu
4. Caller ID/Scroll down
5. Headset jack (2.5 mm)
6. Phone On/Flash
7. Speakerphone
8. Temporary tone dialing key
9. Redial/Pause
10. Mute/Delete
11. Microphone
12. Intercom
13. Change number format
14. Phone Off/Cancel
15. Volume control
16. Phonebook/Scroll up

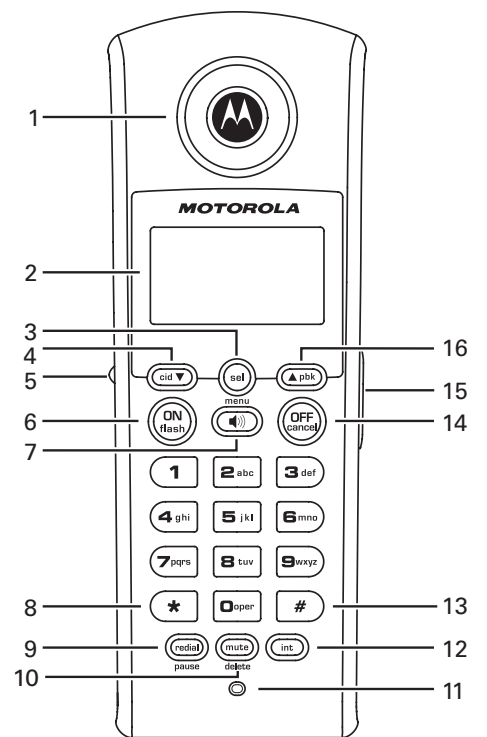

Base Unit Overview

- | | |
|----------------------|------------------------------------|
| 1. Base unit speaker | 7. Menu options |
| 2. Handset cradle | 8. Change option |
| 3. Page | 9. Time set option |
| 4. Charging LED | 10. Mailboxes |
| 5. In Use LED | 11. Answering machine control keys |
| 6. Message display | 12. Volume controls |

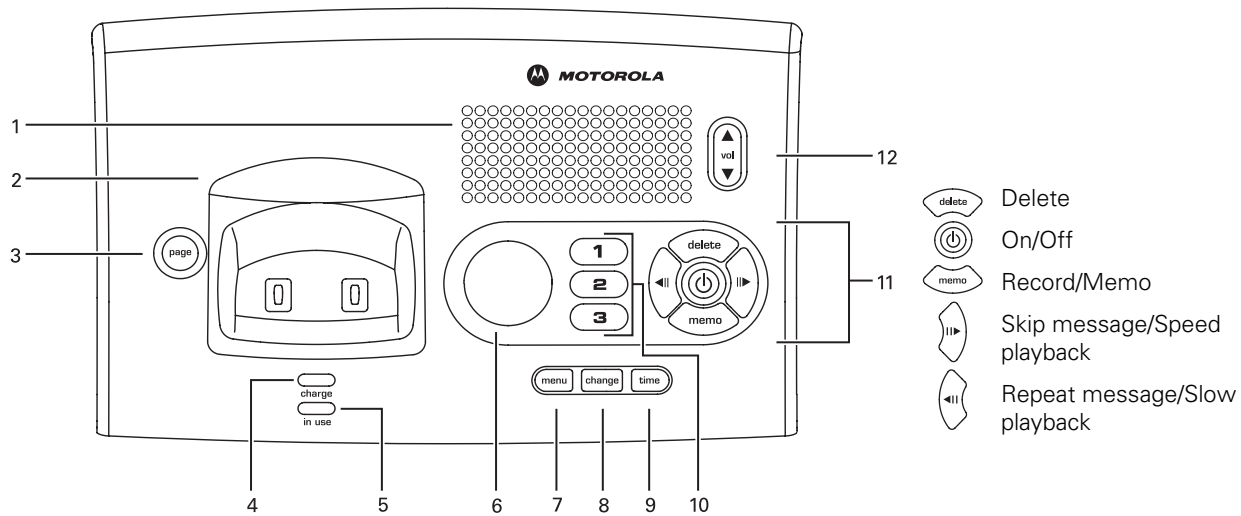

Getting Started

Battery Safety Instructions

- Do not burn, disassemble, mutilate, or puncture the battery. The battery contains toxic materials that could be released, resulting in injury and/or explosion.
- **CAUTION:** There is a risk of explosion if you replace the battery with an incorrect battery type. Use only the battery that came with your phone or an authorized replacement recommended by the manufacturer.
- Keep batteries out of the reach of children.
- Remove batteries if storing over 30 days.
- The rechargeable batteries that power this product must be disposed of properly and may need to be recycled. Refer to your battery's label for battery type. Contact your local recycling center for proper disposal methods.

Installing the Battery

1. Remove any stickers or inserts, if present.
2. Remove the battery door by pressing down on the indentation and sliding downward.
3. Plug the battery connector into the receptacle. (Make sure the black wire is on the left.)
4. Insert the battery into the battery compartment.
5. Replace the battery door.
6. Attach the belt clip (optional).

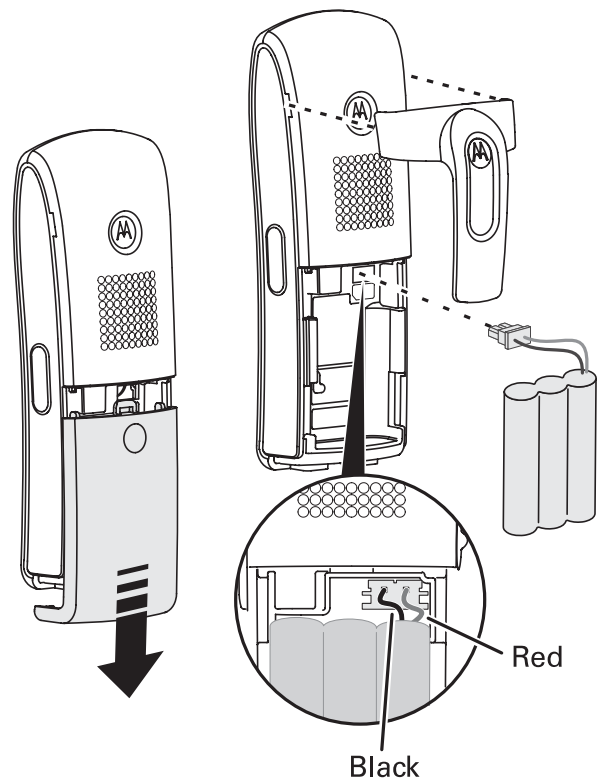

Charging the Handset Battery

The handset of your cordless telephone is powered by a rechargeable battery pack. It charges automatically whenever the handset is in the base unit or charger.

The initial battery charge time is 10–12 hours. After the initial charge, a maintenance charge of eight hours should be sufficient. Be sure to place the handset in its base when not in use to ensure maximum daily performance.

If your handset displays a **PLACE IN CHARGER** message, or the handset is completely dormant (the LCD is blank and does not activate when you press the keys), charge the handset.

NOTE: When in **LOW BATTERY** mode, the keypad sounds, backlighting, and speakerphone features will not work. The features are fully functional after you recharge the battery.

Installing the Base Unit

IMPORTANT! FOR MAXIMUM PERFORMANCE OF YOUR CORDLESS TELEPHONE SYSTEM:

- Choose a central location for your base unit.
- Install your base unit and extension handsets away from electronic equipment, such as personal computers, television sets, and microwave ovens.
- In locations where there are multiple cordless telephones, install base units as far apart as possible.
- Install your telephone equipment away from heat sources and sunlight.
- Avoid excessive moisture, dust, or extreme cold.

Selecting a Location for Your Base Unit

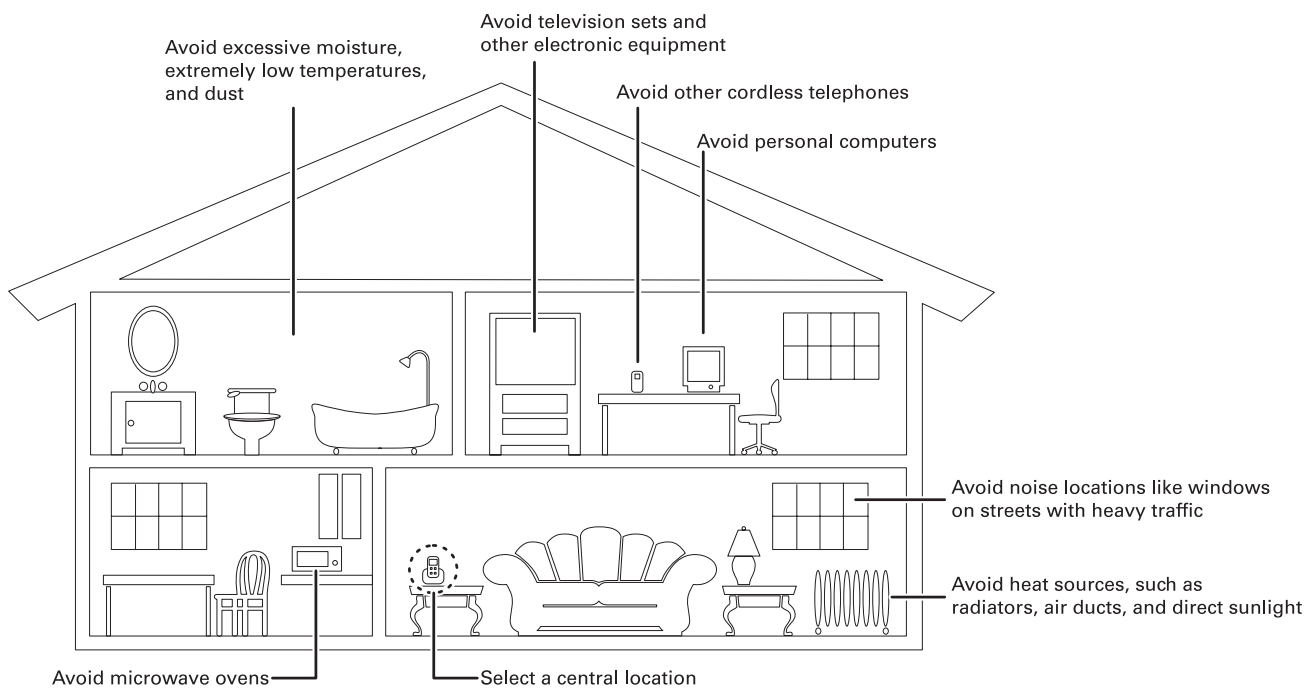

Wall Mounting (Optional)

1. Feed the phone and power cords through the top of the mounting bracket.
2. Connect the phone and power cords to the openings on the bottom of the base unit.
3. Align the tabs of the mounting bracket with the slots on the bottom of the base unit. Snap the mounting bracket firmly in place.

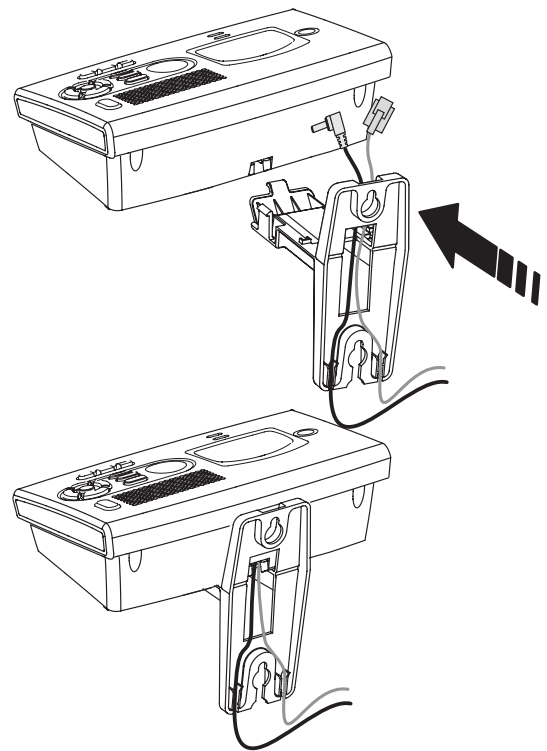

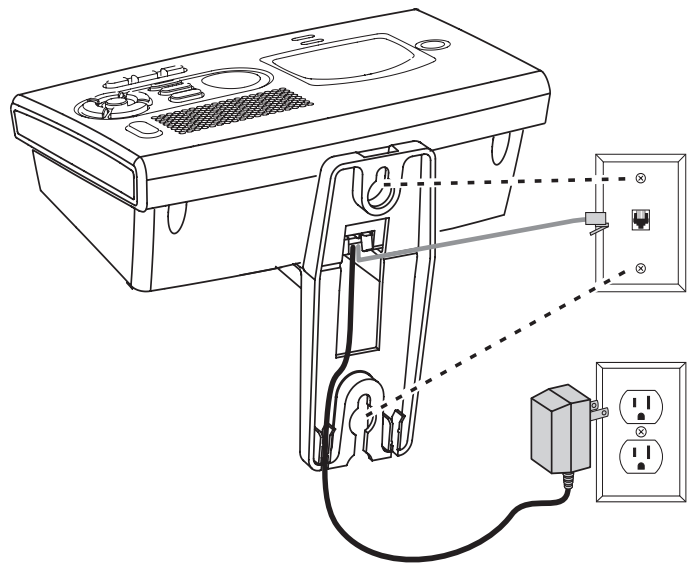

4. Plug the phone cord into the wall jack, and the power cord into an electrical outlet.
5. Mount the base unit on the wall jack. Position the base unit so that the mounting studs will fit into the holes on the wall mount bracket. Slide the base unit down on the mounting studs until it locks into place.



Basic Operations

Handset Display Indicators

Icon	Description
MUTE	Turns on when the microphone is muted
NEW	Turns on when a new call is received and added to the call log
	Turns on when the ringer is muted
	Indicates battery charge status

Base Unit LEDs*

LED	Description
in use	On when the phone is off-hook or when an extension phone is off-hook
charge	On when the handset is charging in its base
mailbox 1, 2, 3	Flashes when there are new messages in the corresponding mailbox Solid when only old messages are in the corresponding mailbox
	Turns on when the answering system is on

*The charge-only bases have only the Charge LED

Making a Call

Press the **ON/FLASH** key on the handset, or the  key to use the speakerphone feature. When you hear the dial tone, dial the number.

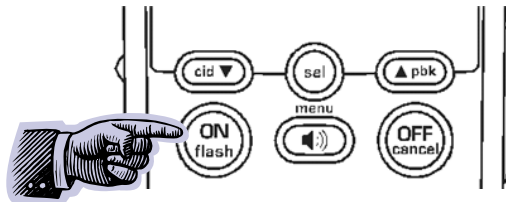

-OR-

Enter the phone number. The phone number appears on the display before it is dialed. If necessary, use the **MUTE/DELETE** key to make corrections or press and hold the **OFF/CANCEL** key to delete the entire number. Press **ON/FLASH** to dial the number.

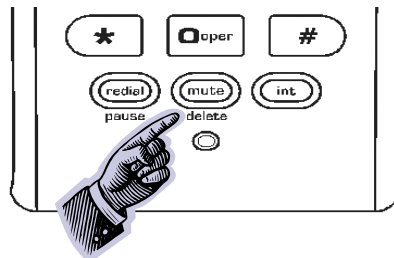

Answering Calls

Press **ON/FLASH**, , or any digit key (0 through 9) to answer a call.

If you subscribe to call waiting:

Press the **ON/FLASH** key to answer the second call. Press **ON/FLASH** again to return to the first call.

Ending a Call

Press the **OFF/CANCEL** key or place the handset in the base unit to end the call.

Speakerphone Operation

Each handset has a built-in speakerphone. This feature allows you to have hands-free conversations—just stand the handset upright on a table or desktop.

To switch between speakerphone and the handset, press the  key.

Adjust Handset Volume

Press the **VOL ▲ ▼** keys on the right side of the handset to adjust the listening volume to a comfortable level.

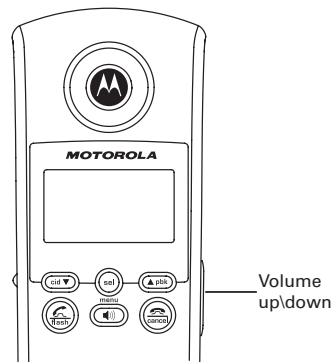

When you reach the maximum or minimum setting, a double beep will sound.

Temporary Ringer Adjustments

When the handset is ringing, to silence the ringer, press **OFF/CANCEL** or **MUTE/DELETE**, or adjust the ringer level to 0 by using the handset volume keys.

This adjustment is temporary. The ringer volume will return to its normal setting once the call is answered or the ringing stops.

Redial Function

1. Press the **REDIAL/PAUSE** key to display the last telephone number dialed from the handset (up to 32 digits).
2. Use the scroll keys to view the last five numbers dialed. A double beep will sound when you reach the beginning or the end of the redial list.
3. Press the **ON/FLASH** or **⏏** key to dial the highlighted number.

Press the **OFF/CANCEL** key to exit the redial review list without dialing a number.

Deleting a Redial Listing

1. Press the **REDIAL/PAUSE** key.
2. Scroll to the desired entry.
3. Press the **MUTE/DELETE** key. A confirmation beep sounds after the entry is deleted.
4. Press **OFF/CANCEL** to exit the review list.

NOTE: If the redial memory is empty and **REDIAL/PAUSE** is pressed, a double beep will sound.

Mute Function

NOTE: The mute feature is only available during a call.

1. Press the **MUTE/DELETE** key. **MICROPHONE MUTED** appears on the display, along with the **MUTE** icon.
2. Press the **MUTE/DELETE** key again to return to normal two-way conversation. **MICROPHONE ON** appears on the display.

Locate a Misplaced Handset

From the base unit, press the **PAGE** key to locate lost handsets. The handsets will beep and **BASE IS PAGING** appears on the display.

To end the page, press **ON/FLASH**, , or any dial pad key (0 through 9, *, #) on the handset, or press **PAGE** again on the base unit.

NOTE: Pressing **OFF/CANCEL** on a handset stops the paging for that handset only.

Phonebook Operations

Your handset can store up to 50 numbers with names. Each memory location holds up to 32 digits for the number and 16 characters for the name.

NOTES: If you have multiple handsets registered to your base unit, the handsets share a common phonebook stored in the base unit. This means that entries inserted by one handset are available to all system handsets, and if you delete a phonebook entry, it disappears from all of the handsets.

Only one handset can access the phonebook at one time. If a second handset attempts to access the phonebook, **NOT AVAILABLE AT THIS TIME** appears on the handset display.

Storing a New Entry

1. Press the **SEL/MENU** key.
2. Scroll to **PHONEBOOK**.
3. Press the **SEL/MENU** key.
4. Scroll to and select **STORE**.
5. Enter the telephone number at the **ENTER NUMBER** prompt.
6. Use the **MUTE/DELETE** key to erase characters to the left of the cursor.
7. Press the **SEL/MENU** key to save the number.
8. Enter the name for the new contact at the **ENTER NAME** prompt. Use the **MUTE/DELETE** key to erase characters to the left of the cursor. Use the **cid** ▼ or ▲ **pbk** keys to move the cursor to the left or right.
9. Press **SEL/MENU** to save the entry. A confirmation tone will sound and the new phonebook entry appears briefly.

Use the table below to enter names and special characters into the phonebook.

KEY	Number of Key Presses								
	1	2	3	4	5	6	7	8	9
1	space	1							
2	A	B	C	2	a	b	c		
3	D	E	F	3	d	e	f		
4	G	H	I	4	g	h	i		
5	J	K	L	5	j	k	l		
6	M	N	O	6	m	n	o		
7	P	Q	R	S	7	p	q	r	s
8	T	U	V	8	t	u	v		
9	W	X	Y	Z	9	w	x	y	z
0	0								
*	*	?	!	/	()			
#	#	'	,	-	.	&			

NOTES:

- If the phonebook is full, the handset will display **PHONEBOOK IS FULL**.
- If the number you are saving is connected to an automated system, you may wish to insert pauses in the number. A pause allows the key presses and the automated system to synchronize. To add a pause, while entering the phone number, press and hold the **PAUSE** key.
- If there is a duplicate number in the phonebook, **NUMBER ALREADY IN PHONEBOOK** appears.

Reviewing/Dialing from the Phonebook

When not on a call, press **▲ pbk**, and the handset jumps directly into phonebook review mode. The first phonebook entry is listed.

Scroll through the phonebook entries using the scroll keys or enter the first character of the name (using the digit keys) and continue navigating.

- OR -

1. Press the **SEL/MENU** key.
2. Scroll to and select **PHONEBOOK**.
3. Scroll to and select **REVIEW**.

NOTE: When reviewing the phonebook, the second line of the display will show the phone number, up to 16 digits. For numbers longer than 16 digits, only the first 13 digits appear. Press the ***** or **#** key to scroll the phone number to see the additional digits. Press **ON/FLASH** or **📞** to dial the number.

Editing a Phonebook Entry

1. Press the **▲ pbk** key, scroll to the desired entry.
2. Press the **SEL/MENU** key. **EDIT NUMBER** appears on the display. Use the **MUTE/DELETE** button to edit the entry.
3. Press the **SEL/MENU** key to save the changes.
4. Follow the same steps to edit the name. A confirmation tone beeps and the updated entry appears on the display briefly.

NOTE: To add a pause in the number, press and hold the **REDIAL/PAUSE** key.

Delete a Single Phonebook Entry

Press the **▲ pbk** key, scroll to the desired entry, and press **MUTE/DELETE**.

Caller ID/Call Waiting ID

Your handset is also capable of displaying caller ID information in conjunction with a call waiting alert signal (**Call Waiting/Caller ID**).

With **Call Waiting/Caller ID**, the caller ID data is displayed so you can decide whether to answer the incoming call, or continue with your current conversation. Your system holds up to 50 caller ID entries.

When you receive new caller ID information your handset shows **NEW** in the lower left side of the display.

NOTES:

- You must subscribe to **Caller ID/Call Waiting** service with your local telephone company to use the feature.
- If no caller ID information is available from the phone company, or you do not subscribe to the service, the display shows **INCOMING CALL**.

Reviewing Caller ID Records

When your systems stores new caller ID records, **NEW** appears on the display.

Press the **cid** ▼ scroll key to review the records.

- OR -

1. Press the **SEL/MENU** key.
2. Scroll to and select **CALL LOG**. Use the scroll keys to review the entries. A double beep sounds when you reach the beginning or end of the log.

After you review all of the new records, the **NEW** message disappears from the display.

NOTE: As when accessing the phonebook, only one handset at a time can access the call log. The other handsets cannot access it at the same time. If this is attempted, **NOT AVAILABLE AT THIS TIME** will display on the second handset.

Storing a Caller ID Entry in the Phonebook

1. Press **cid** ▼ .
2. Scroll to the entry you wish to store. To view alternate phone number formats, press the **#** key repeatedly. The display will cycle through the available dialing options (1 + area code + number, area code + number, number only, etc.).
3. Press **SEL/MENU** to store the displayed number. A confirmation beep sounds and **ADDED TO PHONEBOOK** appears.

NOTES:

- If the system is unable to detect a name or number, **EDIT NAME** or **EDIT NUMBER** appears. You will then need to enter the name or the number.
- If the phonebook is full, **PHONEBOOK IS FULL** appears.
- **NUMBER ALREADY IN PHONEBOOK** appears on the display if the number is already in your phonebook.

Dialing from the Caller ID Log

1. Press **cid** ▼ .
2. Scroll to the entry you wish to dial. Press the **#** key repeatedly to change the dialing format (1 + area code + number, area code + number, number only, etc.).
3. Press **ON/FLASH** or **⏏** to dial the number.

Deleting a Caller ID Record

1. Press **cid** ▼ .
2. Scroll to the entry you wish to delete.
3. Press the **MUTE/DELETE** key to delete the record. A confirmation beep sounds and the previous caller ID record appears.

Deleting All Caller ID Records

1. Press **cid** ▼ .
2. Press and hold the **MUTE/DELETE** key. The handset prompts, **DELETE ALL CALLS?**
3. Press **SEL/MENU** to confirm, or **OFF/CANCEL** to exit without deleting.

Ringer Volume

1. Press the **SEL/MENU** key.
2. Scroll to and select **RINGER VOLUME**. The current ringer volume appears on the display.
3. Press the scroll keys or enter a digit (0 through 6) to the desired ringer volume. The current ring tone plays and the volume bar increases or decreases each time you adjust the setting. At the lowest setting, the display shows the ringer off icon.
4. Press the **SEL/MENU** key to save the setting.

Ringer Tone

1. Press the **SEL/MENU** key.
2. Scroll to and select **RINGER TONE**. The handset prompts you to select **INTERCOM CALL** or **OUTSIDE CALL**.
3. Scroll to and select the desired option.
4. Press **SEL/MENU**. Use the scroll keys or enter a digit (0 through 9) to sample the ring tones.
5. Press the **SEL/MENU** key to save the setting.

Key Tone

1. Press the **SEL/MENU** key.
2. Scroll to and select **KEY TONE**.
3. Select **ON** or **OFF** using the scroll keys.
4. Press the **SEL/MENU** key to save the setting.

Display Language

1. Press the **SEL/MENU** key.
2. Scroll to and select **LANGUAGE**.
3. Scroll to and select **ENGLISH**, **FRENCH**, or **SPANISH**.
4. Press **SEL/MENU** to save the setting.

NOTE:

If you accidentally change your language, follow these steps:

1. Press **OFF/CANCEL** twice to ensure you are at the standby screen.
2. Press the **SEL/MENU** key.
3. Press **▲ pbk** two times.
4. Press the **SEL/MENU** key.
5. Press **▲ pbk** until you see your desired language.
ENGLISH=>INGLES=>ANGLAIS
SPANISH=>ESPANOL=>ESPAGNOL
FRENCH=>FRANCES=>FRANCAIS
6. Press the **SEL/MENU** key to save the setting.

Dialing Method

1. Press the **SEL/MENU** key.
2. Scroll to and select **DIAL TYPE**.
3. Scroll to **tone** or **PULSE**.
4. Press **SEL/MENU** to save the setting.

NOTE: When the phone is set for pulse dialing, you may switch to temporary tone dialing during a call by pressing *. Once pressed, tone will be used for rest of the call. After you hang up, the phone will return to pulse dialing for the next call.

Message Waiting Indicator

If you subscribe to voicemail service from your local telephone company, the **MESSAGE** LED on your base unit blinks when you have a new message.

To stop the LED from blinking (for one occurrence only):

1. Press the **SEL/MENU** key.
2. Scroll to and select **CLEAR MSG WAIT**.
3. Press **SEL/MENU** to turn off the message LED.

Using the Answering System

Your telephone's integrated answering system uses audible prompts that give you access to the system features and help you set up the device.

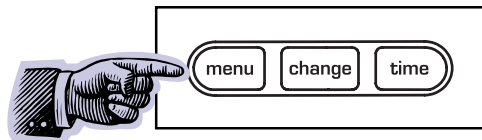

- Press the **MENU** button to access system features (e.g., set base ringer, set security code).
- Press the **CHANGE** button to correct settings.
- Press the **TIME** button to hear the time currently saved in the system, change the time/day/month/year, and store new settings.

NOTE: You can exit any feature by pressing any mailbox button.

Before setting the features for your new answering system, make sure it is turned on.

Turning the Answering System On or Off

Press the  (POWER) button to turn the system on or off.

- The system announces, "*Answering machine on,*" and the **POWER** light is on.
- The system announces, "*Answering machine off,*" and the **POWER** light is off.

NOTE: If leave your answering system turned off, after 10 rings the system prompts the caller to "**Please enter your security code.**" Your outgoing message or announcement does not play, and the caller cannot leave a message. The prompt is for remote access to your system. See Remote Access for additional information on the feature.

Answering System Feature Overview

You can set up one feature at a time, or you can set up the first feature, and then move on to set up the features in sequence. (See the Feature Summary on the following page for a listing of all menu items.)

NOTE: You can exit any feature by pressing any mailbox button. The system automatically saves your messages until you delete them. You can store approximately 15 minutes of messages, memos, and announcements (maximum of 99 messages). A message or memo can be up to four minutes long.

- To access a feature, press and release **MENU** until you hear the system announce the feature you wish to set (Refer to the Feature Summary for a description of the features and your choices).
- Press **TIME** to hear the current setting, and to save a new setting.
- Press **CHANGE** until you hear your desired setting.
- Press **TIME** to confirm your selection.

Menu Features Summary

SYSTEM ANNOUNCES	DESCRIPTIONS/DIRECTIONS
"Record outgoing message"	Record a message that callers will hear when your answering system is turned on.
"Set security code" *50	Set the code you will use to access features and functions from a remote touch-tone phone. Choose a two-digit number from 40 to 99.
"Set audible message alert" *Off On	When the message alert feature is turned on, the base beeps once every 10 seconds when new messages are received.
"Set announce only" *Off On	When the system is set to announce only, callers hear your announcement, but cannot leave a message.
"Set base ringer" *On Off	Turn the base ringer on or off.
"Set number of rings" 2 *4 6 Toll saver	Choose how many times the phone will ring before the system answers. With toll saver active, the system answers after two rings when you have new messages and after four rings when you have no new messages.

*Indicates default setting

Outgoing Messages and Announcements Overview

You can record both an outgoing message and an announce-only message.

- Use the normal greeting when you want the system to record messages from callers.
- Use an announce-only greeting when you want to give information to callers, but you do not wish to accept messages.

NOTE: If you choose not to record your own greetings, the system provides pre-recorded messages. The normal pre-recorded greeting says:
"Hello. I'm unable to answer your call right now. Please leave your name, number, and a message after the tone."

The pre-recorded announce-only message says:
"Hello, I'm unable to answer your call right now. Please call again. Thank you."

To set which announcement your callers will hear when the system answers a call, turn the announce feature on or off. (The system comes set to receive messages from callers. Refer to "Answering System Feature Overview" for more information.)

Recording Your Greeting

1. With the system set to the desired answer mode (normal or announce-only) repeatedly press **MENU** until the system announces "**Record outgoing message.**"
2. Press **MEMO**. After you hear "Now recording" followed by a beep, speak toward the base to record an announcement up to 90 seconds long.

If you assign different mailboxes to different people, be sure to tell callers in your announcement to press 1, 2, or 3 to leave their message in the appropriate mailbox. (E.g., "Thank you for calling. To leave a message for Karen, press 1 now; to leave a message for Tim, press 2 now; to leave a message for Chad, press 3 now; or, just wait for the beep.") Remember to leave a few seconds at the end of your greeting to allow callers enough time to select a mailbox.

3. Press any **MAILBOX (1, 2, 3)** button to stop recording. The system plays back your recorded message.

NOTE: The system records your announcement only for the currently selected answer mode (normal or announce-only). To confirm or change the answer mode, refer to "Answering System Feature Overview."

Review Your Announcement

When you have new messages or memos, the **MAILBOX (1, 2, 3)** light for each mailbox with new messages will flash.

1. Repeatedly press **MENU** until the system announces, "**Record outgoing message.**"
2. Press any **MAILBOX (1, 2, 3)** button. The system plays the current greeting.

Delete Your Announcement

Press **DELETE** while reviewing your announcement. The system will use the pre-recorded greeting until you record a new one.

NOTE: If the system has less than 30 seconds of recording time left, it automatically turns off. The system will still answer after 10 rings, announce "**Memory full, please enter your security code,**" then wait for the caller to enter the code to access remote functions. (See Remote Access for details.) The system will not accept messages.

Setting the Clock

NOTE: A flashing "CL" in the message window indicates that you must set the correct day and time at the base unit.

1. Press the **TIME** button. The system announces the time and day of the week, followed by *"To set day and time, press TIME/SET."*
2. Press the **TIME** button. The system announces the day.
3. Press the **CHANGE** button repeatedly until the system announces the correct day.
4. Press the **TIME** button to save the new setting. The system announces the setting.
5. Press the **CHANGE** button repeatedly until the system announces the correct hour.
NOTE: Be sure to select the correct time of day (e.g., 3 AM or 3 PM).
6. Press the **TIME** button to save the new setting. The system announces the minute.
7. Press **CHANGE** to advance the minutes one at a time. **–OR–** Press and hold the **CHANGE** button to advance the minutes in increments of 10.
8. Press the **TIME** button to save the new setting. The system announces the year.
9. Press **CHANGE** to advance the year one at a time. **–OR–** Press and hold **CHANGE** to advance the years in increments of 10. When the system announces the correct year, press **TIME**. The system announces the clock setting.

About Mailboxes

The answering machine has three voice mailboxes. Callers using a touch-tone phone can select the mailbox in which their messages will be recorded by pressing 1, 2, or 3 while the system plays the outgoing announcement. Otherwise, messages will be recorded in mailbox 1.

Listen to Messages

A mailbox key will flash if you have new messages. If all messages in that mailbox are old, the key will glow steadily.

1. Press the **MAILBOX (1, 2, 3)** button for the mailbox you want to review. The system announces the mailbox number, the number of new messages, and the number of old messages. The system then plays only new messages in the mailbox. After playing all of your new messages, press the **MAILBOX (1, 2, 3)** button again to hear all (old) messages.

Before each message or memo plays, the system announces the day and time it was received. While a message plays, the message window displays the number of that message.

2. Press **REPEAT/SLOW** during playback to hear a message again. If you press **REPEAT/SLOW** twice in the first two seconds of a message, the system will replay the previous message.
3. Press **SKIP/SPEED** during playback to skip to the next message.
4. Press and hold **SKIP/SPEED** or **REPEAT/SLOW** during message playback to speed up or slow down playback of a message.

After playing the last message in a mailbox, the system announces "**End of messages.**" If the system has less than five minutes of recording time left, it announces the remaining time.

Press the **MAILBOX (1, 2, 3)** button at any time during playback to exit message playback. There is a confirmation beep.

Adjust Playback Volume

Press **VOL ▲** or **VOL ▼** to adjust playback volume to a comfortable level. The system beeps three times when you reach the highest or lowest volume setting. If volume is set to level 1, you cannot hear incoming messages.

Delete a Specific Message

NOTE: Deleted messages cannot be recovered.

Press **DELETE** while a message is playing to delete only that message.

Delete All Messages in a Mailbox

1. Press **DELETE**. The system announces, "**Please select mailbox.**"
2. Press the desired mailbox button. The system erases all old messages and memos in that mailbox.

Recording a Memo

You can record a memo up to four minutes long to store as an incoming message.

1. Press and release **MEMO**. The system announces, "**Please select mailbox.**"
2. Press the mailbox button to select a mailbox in which to store the memo. After the system announces "**Now recording,**" speak towards the base microphone. The message window displays the length of your memo, up to 99 seconds. If you record a longer memo, 99 flashes until you finish.
3. To stop recording, press mailbox again.

Call Screening

NOTE: This feature is only available from the base unit.

1. Set the base unit playback volume to a level greater than 1 to hear messages as they are left.
2. Press the **ON/FLASH** button on the handset to stop recording and answer the call.
3. Set the volume level to 1 if you do not wish to hear incoming messages.

NOTE: The system will save the portion of the message recorded prior to you picking up the call.

Message Window Display

WINDOW DISPLAYS	TO INDICATE:
0	No messages in any mailbox
0-99 ↔ F	Memory is full or the total number of messages is 99
Counting 1 to 99	Duration of announcement or memo recording (maximum length of announcement is 90 seconds)
99 (flashing)	New message number during message playback
1-8 (steady for one second)	Indicates volume level selected when VOL+ or VOL- is pressed
40-99	Current remote access code while setting
A	Announce only mode
On or Of (steady for one second)	Displayed when any setting is changed to on or off
CL ↔ normal display	Clock needs to be set
--	System is answering a call or is in remote operation
-- (flashing)	System is in programming mode or initializing

Remote Access

You can use many features of the answering system remotely from a touch-tone phone.

1. Dial your telephone number.
2. When the system answers, enter your remote access code (preset to 50). The system beeps once and announces the number of new messages on the system.
3. Enter a remote command (see Remote Access Commands).
4. Press ***0** to exit remote operation.

Remote Voice Menu Access

The system has voice prompts to help you with remote operation.

Press ***5** to hear the menu while remotely connected to the answering system.

REMOTE ACCESS COMMANDS

FUNCTION	COMMAND
Play messages in a mailbox	Press #, then the desired mailbox number (1, 2, 3). The system plays new messages. If there are no new messages, the system plays old messages.
Repeat a message	Press #4 while message is playing; press #4 twice to replay previous message.
Skip a message	Press #6 while message is playing; each press advances to next message.
Stop Play menu options	Press #5 .
Save messages	Hang up.
Delete message	Press #9 while message is playing.
Review announcement	Press #7 ; system plays announcement, then beeps.
Record announcement	Press *7 ; after beep, record announcement, press #5 to stop. System plays back announcement.
Record memo	Press *8 , then the mailbox number where you want memo recorded; speak after the system announces " <i>Now recording.</i> " Press #5 to stop.
End remote access call	Press *0
Turn system off	Press #0 ; the system announces, " <i>Answering machine off.</i> " Press #0 again to turn the system back on.
Turn system on	When system is off, it answers after 10 rings and announces, " <i>Please enter your security code.</i> " Enter your remote access code.

NOTE: If no key is pressed within 10 seconds of entering remote access, the voice menu will be announced. After the voice menu announcement, if no key is pressed within 20 seconds, the remote access call will automatically end.

Special Features

If you have at least two handsets registered to your base unit, you can use the intercom and call transferring features. Each handset is named **HANDSETX**. The X represents the order (1, 2, 3, 4) in which the handset was registered to the base unit. (See the user guide for the expansion handset for more information.)

Intercom Calls

When not on a call,

1. Press the **INT** key on any handset. **ENTER HANDSET #** appears on the display.
2. Enter the number of the handset you wish to page (e.g., to call **HANDSET2**, press 2).
3. Press **INT**, **ON/FLASH**, **Ⓜ**), or any of the dial pad keys on **HANDSET2** to answer the intercom call. The screen on both handsets displays **INTERCOM**.
4. Press **INT** or **OFF/CANCEL** on either handset to end the call.

NOTE: If a handset is out of range, or you receive an outside call while attempting an intercom call, the screen displays **UNABLE TO CALL TRY AGAIN**.

Call Transfer

During an outside call, you can transfer the call from one handset to another.

1. Press the **INT** key on the handset with the outside call. **ENTER HANDSET #** is displayed.
2. Enter the number of the handset to which you wish to forward the call. **CALL FORWARDED** appears on the screen.
3. To answer the call, press the **ON/FLASH** button on the second handset.

NOTE: If the second handset does not respond after approximately 60 seconds, the outside call returns to the first handset, and **CALL BACK** appears.

If the returned call is not answered within 60 seconds, the outside call ends automatically.

Conference Call

Use the conference feature to enable two or more handsets to participate in the same outside call.

1. While the first handset is on an outside call, the second handset can press **ON/FLASH** or .
2. A timer (e.g., **CONF. 00:01:25**) appears on the displays of both handsets showing the length of the call.

In Case of Difficulty

The suggestions below should solve most problems you might encounter while using your phone. If you still have difficulty after trying these suggestions, visit us on the web at www.motorola.com/cordless.

The phone doesn't work at all

- Make sure the power cord is plugged firmly into the base unit and an electrical outlet.
- Make sure the phone cord is plugged firmly into the base unit and the telephone wall jack.
- Make sure the battery is properly inserted and fully charged. **PLACE IN CHARGER** on the display indicates that the batteries need charging.

No dial tone

- First, try all the suggestions above.
- If you still don't hear a dial tone, disconnect the base unit from the telephone jack and connect a different phone. If there is no dial tone on that phone, contact your local telephone company.

You get noise, static, or a weak signal when you're away from the base unit

- You may be out of range. Either move closer to the base unit, or relocate it.
- The layout of your home may be limiting the range. Try moving the base unit to another position. (See Installing the Base Unit on page 7.)

You get noise, static, or a weak signal even when you're near the base unit

- Household appliances plugged into the same circuit as the base unit can sometimes cause interference. Try moving the appliance or the base unit to another outlet.

The handset does not ring when you receive a call

- Make sure you have the ringer activated. (See Ringer Tone and Ringer Volume sections.)
- Make sure the telephone line cord is plugged firmly into the base unit and the telephone wall jack.
- Make sure the power cord is plugged into the base unit and an electrical outlet.
- Move closer to the base unit.

You hear other calls while using your phone

- Disconnect your base unit from the telephone jack, and plug in a different telephone. If you still hear other calls, contact your local telephone company.

Common Troubleshooting Steps for Your Cordless Phone

If the handset or base unit does not seem to be responding normally, then try putting the handset in its base. If it does not seem to respond, do the following (in the order listed):

1. Disconnect the power to the base.
2. Disconnect the handset battery.
3. Wait a few minutes.
4. Connect power to the base unit.
5. Re-install the battery.
6. Wait approximately 60 seconds for the handset to re-establish its link with the base.

Warranty

Motorola Limited Warranty for Consumer Products, Accessories, and Software Purchased in the United States or Canada
What Does this Warranty Cover?

Subject to the exclusions contained below, Motorola, Inc. warrants its cordless telephones ("Products"), Motorola-branded or certified accessories sold for use with these Products ("Accessories"), and Motorola software contained on CD-ROMs or other tangible media and sold for use with these Products ("Software") to be free from defects in materials and workmanship under normal consumer usage for the period(s) outlined below. This limited warranty is a consumer's exclusive remedy, and applies as follows to new Motorola Products, Accessories, and Software purchased by consumers in the United States or Canada, which are accompanied by this written warranty:

Products and Accessories as defined above, unless otherwise provided for below. Length of coverage: one (1) year from the date of purchase by the first consumer purchaser of the product unless otherwise provided for below.

- **Decorative Accessories and Cases.** Decorative covers, bezels, PhoneWrap[®] covers and cases. Length of coverage: limited lifetime warranty for the lifetime of ownership by the first consumer purchaser of the product.
- **Monaural Headsets.** Ear buds and boom headsets that transmit mono sound through a wired connection. Length of coverage: limited lifetime warranty for the lifetime of ownership by the first consumer purchaser of the product.
- **Products and Accessories that are Repaired or Replaced.** Length of coverage: The balance of the original warranty or for ninety (90) days from the date returned to the consumer, whichever is longer.
- **Software.** Applies only to physical defects in the media that embodies the copy of the software (e.g. CD-ROM, or floppy disk). Length of coverage: ninety (90) days from the date of purchase.

Exclusions

Normal Wear and Tear. Periodic maintenance, repair, and replacement of parts due to normal wear and tear are excluded from coverage.

Batteries. Only batteries whose fully charged capacity falls below 80% of their rated capacity and batteries that leak are covered by this limited warranty.

Abuse & Misuse. Defects or damage that result from: (a) improper operation, storage, misuse or abuse, accident or neglect, such as physical damage (cracks, scratches, etc.) to the surface of the product resulting from misuse; (b) contact with liquid, water, rain, extreme humidity or heavy perspiration, sand, dirt or the like, extreme heat, or food; (c) use of the Products or Accessories for commercial purposes or subjecting the Product or Accessory to abnormal usage or conditions; or (d) other acts which are not the fault of Motorola, are excluded from coverage.

Use of Non-Motorola Products and Accessories. Defects or damage that result from the use of Non-Motorola branded or certified Products, Accessories, Software or other peripheral equipment are excluded from coverage.

Unauthorized Service or Modification. Defects or damages resulting from service, testing, adjustment, installation, maintenance, alteration, or modification in any way by someone other than Motorola, or its authorized service centers, are excluded from coverage.

Altered Products. Products or Accessories with (a) serial numbers or date tags that have been removed, altered, or obliterated; (b) broken seals or that show evidence of tampering; (c) mismatched board serial numbers; or (d) nonconforming or non-Motorola housings, or parts, are excluded from coverage.

Communication Services. Defects, damages, or the failure of Products, Accessories or Software due to any communication service or signal you may subscribe to or use with the Products, Accessories or Software is excluded from coverage.

Software Embodied in Physical Media. No warranty is made that the software will meet your requirements or will work in combination with any hardware or software applications provided by third parties, that the operation of the software products will be uninterrupted or error free, or that all defects in the software products will be corrected.

Software NOT Embodied in Physical Media. Software that is not embodied in physical media (e.g. software that is downloaded from the internet), is provided "as is" and without warranty.

Who is Covered

This warranty extends to the first end-user purchaser, only.

What will Motorola Do?

Motorola, at its option, will at no charge repair, replace or refund the purchase price of any Products, Accessories or Software that does not conform to this warranty. We may use functionally equivalent reconditioned/refurbished/pre-owned or new Products, Accessories or parts. No data, software, or applications added to your Product, Accessory or Software, including but not limited to personal contacts, games, and ringer tones, will be reinstalled. To avoid losing such data, software and applications please create a back up prior to requesting service.

How to Get Warranty Service or Other Information

In the USA, call

1-800-353-2729

TTY 1-888-390-6456

In Canada, call:

1-800-461-4575

TTY 1-888-390-6456

For accessories and software, please call the telephone number designated above for the product with which they are used. You will receive instructions on how to ship the Products, Accessories, or Software, at your expense, to a Motorola Authorized Repair Center. To obtain service, you must include: (a) a copy of your receipt, bill of sale or other comparable proof of purchase; (b) a written description of the problem; (c) the name of your service provider, if applicable; (d) the name and location of the installation facility (if applicable) and, most importantly; (e) your address and telephone number.

What Other Limitations Are There?

ANY IMPLIED WARRANTIES, INCLUDING WITHOUT LIMITATION THE IMPLIED WARRANTIES OF MERCHANTABILITY AND FITNESS FOR A PARTICULAR PURPOSE, SHALL BE LIMITED TO THE DURATION OF THIS LIMITED WARRANTY, OTHERWISE THE REPAIR, REPLACEMENT, OR REFUND AS PROVIDED UNDER THIS EXPRESS LIMITED WARRANTY IS THE EXCLUSIVE REMEDY OF THE CONSUMER, AND IS PROVIDED IN LIEU OF ALL OTHER WARRANTIES, EXPRESS OR IMPLIED. IN NO EVENT SHALL MOTOROLA BE LIABLE, WHETHER IN CONTRACT OR TORT (INCLUDING NEGLIGENCE) FOR DAMAGES IN EXCESS OF THE PURCHASE PRICE OF THE PRODUCT, ACCESSORY OR SOFTWARE, OR FOR ANY INDIRECT, INCIDENTAL, SPECIAL OR CONSEQUENTIAL DAMAGES OF ANY KIND, OR LOSS OF REVENUE OR PROFITS, LOSS OF BUSINESS, LOSS

OF INFORMATION OR DATA, SOFTWARE OR APPLICATIONS OR OTHER FINANCIAL LOSS ARISING OUT OF OR IN CONNECTION WITH THE ABILITY OR INABILITY TO USE THE PRODUCTS, ACCESSORIES, OR SOFTWARE TO THE FULL EXTENT THESE DAMAGES MAY BE DISCLAIMED BY LAW.

Some states and jurisdictions do not allow the limitation or exclusion of incidental or consequential damages, or limitation on the length of an implied warranty, so the above limitations or exclusions may not apply to you. This warranty gives you specific legal rights, and you may also have other rights that vary from state to state or from one jurisdiction to another.

Laws in the United States and other countries preserve for Motorola certain exclusive rights for copyrighted Motorola software such as the exclusive rights to reproduce and distribute copies of the Motorola software. Motorola software may only be copied into, used in, and redistributed with, the Products associated with such Motorola software. No other use, including without limitation disassembly of such Motorola software or exercise of the exclusive rights reserved for Motorola, is permitted.

Technical Specifications

FREQUENCY CONTROL

Crystal Controlled
PLL synthesizer

TRANSMIT FREQUENCY

Base: 5744.736 - 5825.952 MHz
Handset: 2401.056 - 2482.272 MHz

RECEIVE FREQUENCY

Base: 2401.056 - 2482.272 MHz
Handset: 5744.736 - 5825.952 MHz

CHANNELS

95 channels

NOMINAL EFFECTIVE RANGE

Maximum power allowed by FCC and IC. Actual operating range may vary according to environmental conditions at the time of use.

WEIGHT

Handset: 102 g (excluding batteries)
Base: 141 g
Charge-only base: 55 g

POWER REQUIREMENTS

Handset: 3.6 V 600 mAh NiMH
Base: 8 V DC @ 650 mA
Charge-only base: 8 V DC @ 200 mA

MEMORY

Phonebook: 50 memory locations; up to 32 digits for number, 16 characters for name, per location
CID: 50 records

SIZE

Handset: 136 mm x 47 mm x 29.5 mm (including antenna)
Base: 110 mm x 108.40 mm x 55.66 mm
Charge-only base: 80 mm x 78 mm x 54 mm

SPECIFICATIONS ARE TYPICAL AND MAY CHANGE WITHOUT NOTICE



MOTOROLA

E51 Series

Digital Cordless Phone
5.8 GHz Expandable

Model Family: MD7161

525918-001
01/06